

80052-FB SINGLE HOPPER MOUNT ASSEMBLY
With 1 1/4" ACCELERATOR & GRINDER SPIKE INCLUDES:

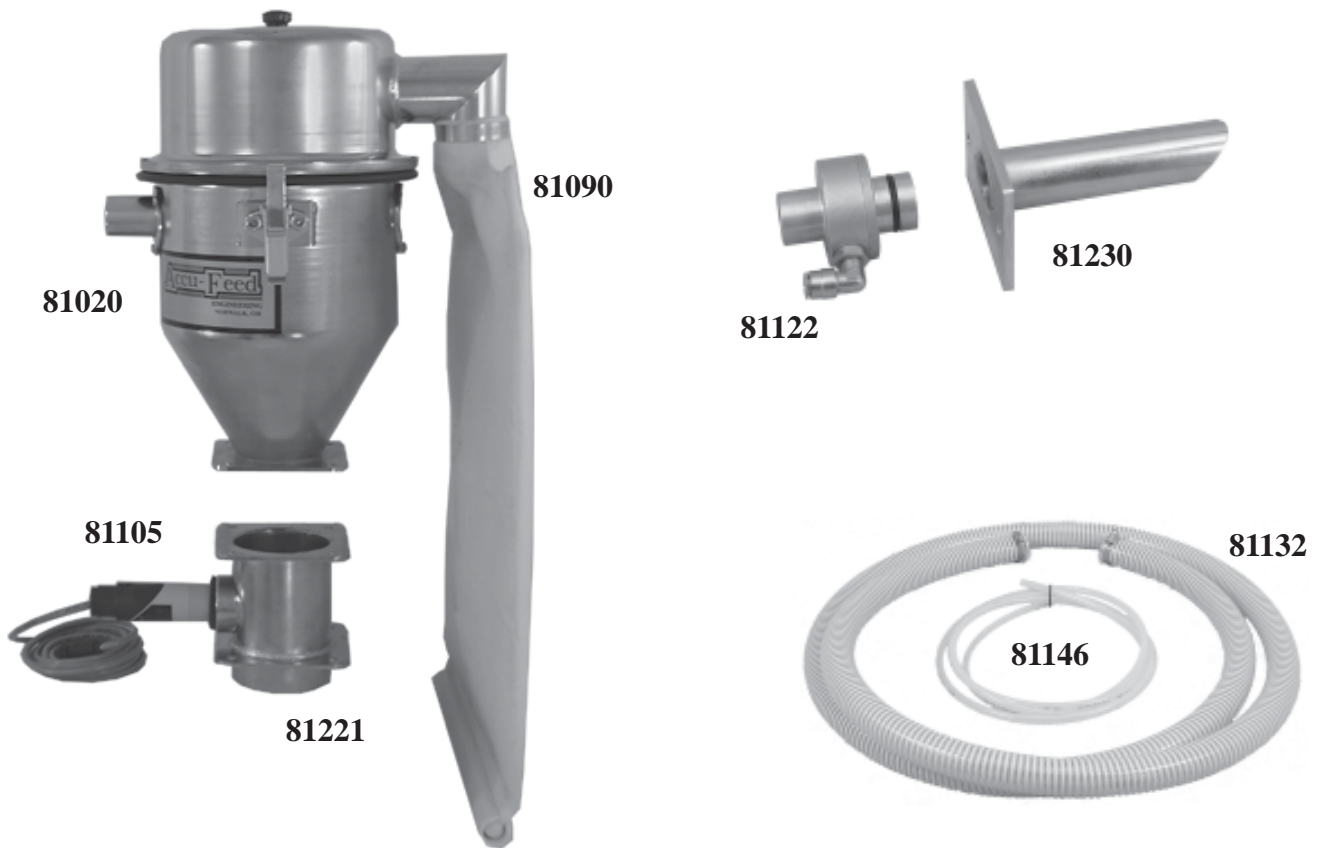

- 81020 Hopper Assembly for 1 1/4" Hose
- 81090 Filter Bag Assembly
- 81105 Sensor
- 81122 1 1/4" Accelerator
- 81132 15 Feet of 1 1/4" Material Transfer Hose w/Clamps
- 81146 10 Feet of 3/8" Air Line Tubing
- 81221 1" Tube w/Flange for Hopper Mounting (Other Sizes Available)
- 81230 Grinder Spike for 1 1/4" Accelerator
- 81800 Single Loader Standard Control
Installation & Operational Manual



NOTE: Order 80053-FB for this assembly without 81800 control.

Accu-Feed
ENGINEERING

50 Newton Street - P.O. Box 404 - Norwalk, OH 44857-0404
Phone: 1-888-844-2228 Fax: 1-888-717-2228
Email: info@accu-feed.com Website: www.accu-feed.com